

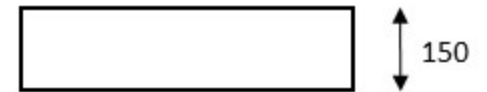

L6249
SHOWER ENCLOSURE

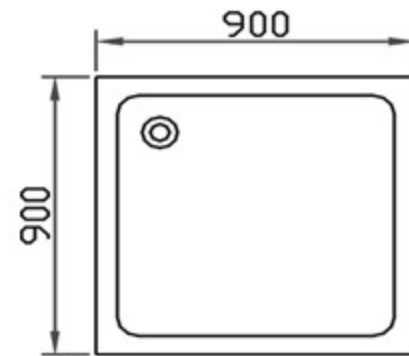
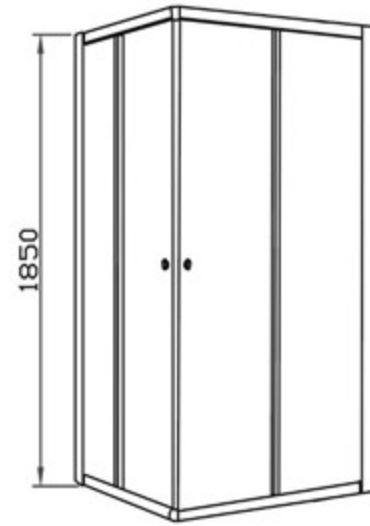

Installation Instruction of L6249

Dear sir and madam,
Thank you for using our relaxed sanitary products. Please read this instruction completely before you install the product to ensure you can install our products faster and safer.

Preparations for installation:

Please read this manual carefully after unpacking, verify whether the steam shower room is damaged by transportation, check the accessory according to the packing list. Please inform the local agency if you have any problem or enquiry, you will get a satisfied reply.

Tools for installation:



Rotary hammer drill with 6mm bit



Cross-point screw driver



Tape



Sealant



Square

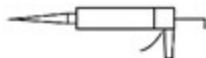

Sealant gun



Plastic hammer



Pencil



Gradienter

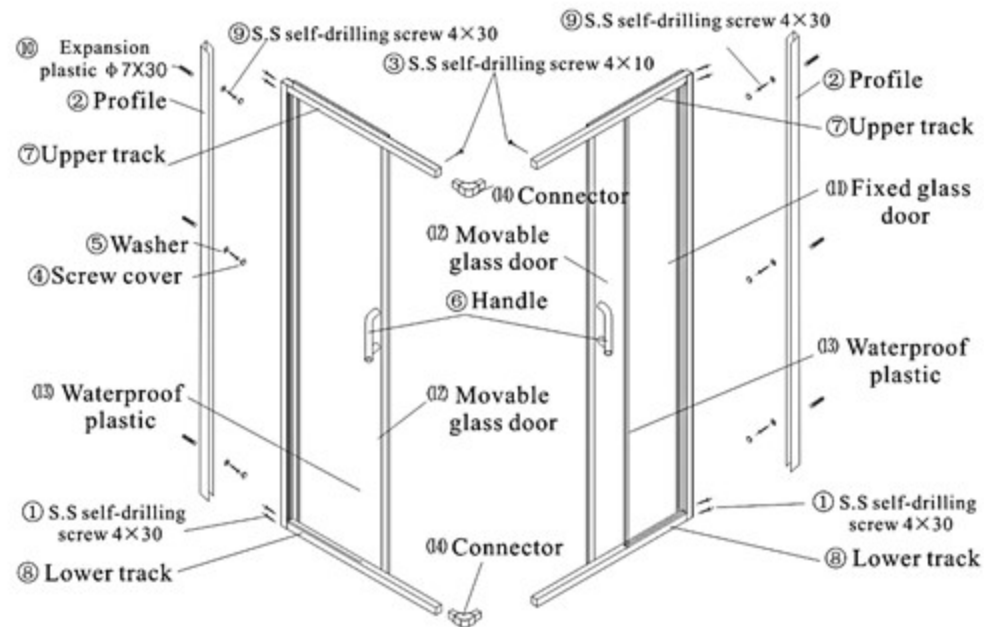

Illustration of parts

No	Description	Qty	No	Description	Qty
1	S.S self-drilling screw 4×30	8	8	Lower track	2
2	Profile	2	9	S.S self-drilling screw 4×30	6
3	S.S self-drilling screw 4×10	4	10	Expansion plastic ϕ 7X30	6
4	Screw cover	6	11	Fixed glass door	2
5	Washer	6	12	Movable glass door	2
6	Handle	2	13	Waterproof plastic	2
7	Upper track	2	14	Connector	2

Installation procedure:

1. Installation of steadier:

Level the steadier with gradien.
(See the figure)

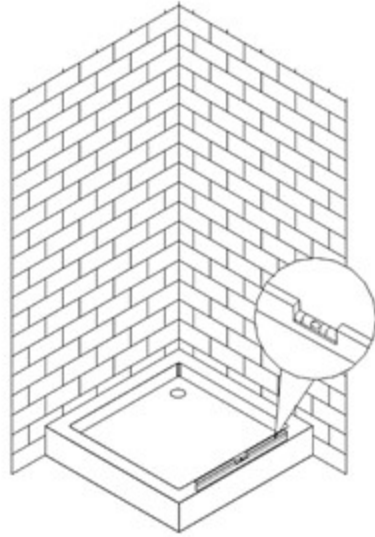

Figure 1

2. Installation of profile:

Make marks of the screw hole of profile on the wall and drill holes against these marks. Then insert the expansion plastics into these holes. And then screw the profile on the wall. (See the figure)

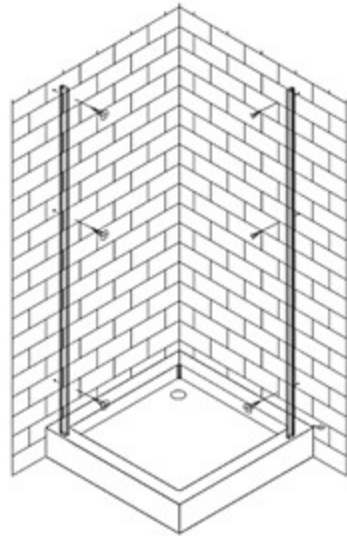

Figure 2

3. Installation of fixed glass door:

Coapt the left door and the right door to the left profile and right profile, respectively. (The fixed glassed are installed to the upper track and lower track in advance). Then connect the tracks with connector. (See the figure)

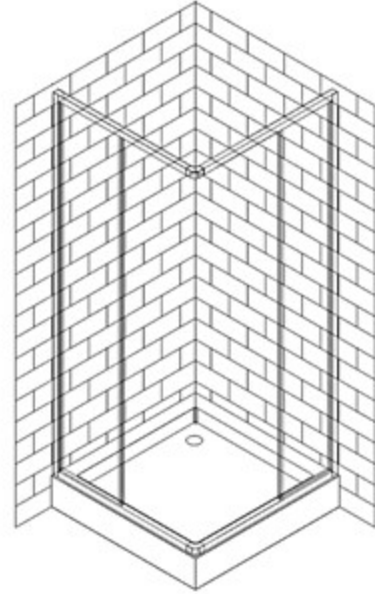

Figure 3

4. Installation of movable door:

Install the wheels onto the glass, then screw the round plastic onto the track. (Round plastic is used in making the movable glass doors in proper positions when they are closed). Then install these glass doors to the tracks and try to keep the door moving smoothly then close the doors. If there is an interstice between the movable doors when closing, please adjust the screw on the wheel.

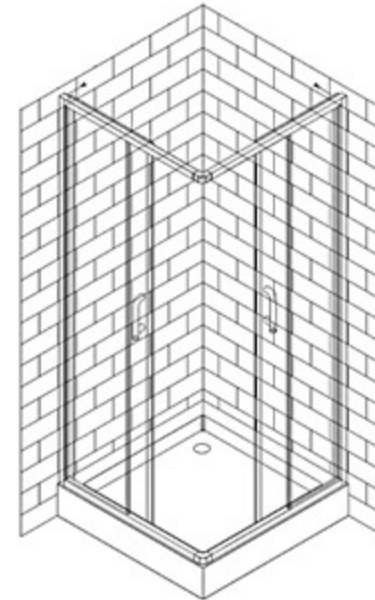

Figure 4

5. Installation of waterproof plastic:

Coapt the waterproof plastic to the edge of the fixed glass.

6. Drill a hole sized $\phi 3.5\text{mm}$ on two sides of left profile, so does the right profile. Then screw the profile with M4x10 screw. (See figure 4)

7. Sealing

Apply sealant between upper track and the steadier, between glass door frame and the wall, so that the waterproof function works. Everything is done. So this shower enclosure will serve you after 24 hours.